

Double Sheet Detection System E20

Electro magnetic principle - microcontroller based

Single - sided contact double sheet control of ferrous materials

No force after measurement

Exchangeable sensors for double sheet control

from 0.1 to 12 mm (.004 to 0.472 in.) sheet thickness

Optional version 4P allows the connection of up to four sensors

THE ROLAND PLUS

- ▶ All common Fieldbus standards
- ▶ Highest air gap tolerance



- Digital display of sheet thickness and operations parameter
- Programmable for 255 different sheet thicknesses
- Monitoring of over gauge and under gauge limits
- Monitoring of operating voltage and measuring time
- Opto coupled 9 respectively 11-Bit PLC input interface
- Selectable interfaces:
 - opto coupled RS232 interface
 - Relay or opto coupled output for under gauge, nominal gauge, over gauge and enable
 - all common fieldbus technologies



Description:

When sheets are fed automatically, two or more sheets may be fed inadvertently into a processing machine. This can damage tools, cause halt in production or result in expensive repairs. The double sheet detector E20 can reliably prevent this from occurring. In addition to the connection of one sensor an option is available to connect four sensors of the same type (E20-4P).

The system can also be used for Hidden Parts Detection. The sensor switching is controlled either sequentially by the PLC or automatically in the new **sequencer mode**. This function eliminates the time-consuming switching of the measuring channel or the program by the PLC. A measurement of 4 separate sheets of 1.0 mm thickness with the P42AGS sensor and a 120% double sheet threshold takes less than 305 ms by using the **sequencer**. In contrast the same measurement with program switching by the PLC takes more than 700 ms.

Function:

The double sheet detector is based on the electromagnetic principle. It monitors ferromagnetic sheets with single sided sensors and exerts forces during the monitoring process only. A change of the sheet thickness results in a change of induction. The system calculates the sheet thickness from this change. Corresponding to the pre-set limits 0-sheet, 1-sheet or 2-sheets signals are generated.

The control unit is available in 3 versions B, C and fieldbus, for feature see below.

All systems can store 255 parameters sets (thicknesses). The features and the version are included in the system description. Standard systems have a 24 V parallel interface for selection of the 255 parameter sets (programs). For fieldbus systems the selection of programs is done via the fieldbus

Technical data:

Operating voltage: 24 V DC \pm 4 V
 Power consumption: < 120 W
 Protection category: IP 65
 Ambient temperature: 0 - 50 ° C
 Weight: approx. 1.5 kg (3.3 lbs)
 Signal inputs: galvanically isolated 24 V DC with joint common

Signal outputs:	Version B:	Version C, Fieldbus:
Max. switching voltage:	dry two way contacts	galvanically isolated with optocoupler
Max. switching current:	250 V AC	50 VAC
Max. switching power:	1 A	0.15 A
	240 W / 200 V A	100 mW

Standard-Version

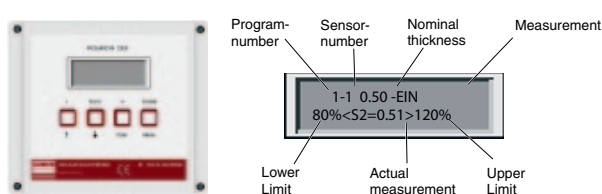

Fieldbus-Version

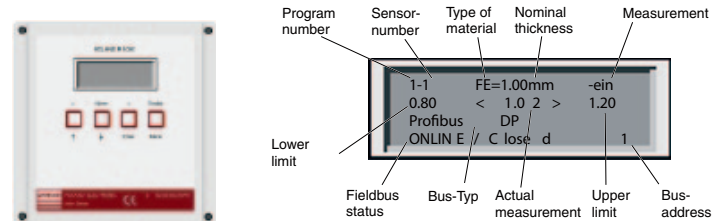

E20-xx-x-x-xx

Number of sensors: -- : 1 sensor
 4P : up to 4 sensors
 Version: B : Standard
 C : Data backup via RS232
 Outputs: O : Opto coupler
 R : Relais
 Enclosure: -- : Wall mount
 FP : Panel mount

Example: E20-C-O for one sensor, data backup / remote control via RS 232, optocoupler signal

System description:

E20-xx-xx-S

Number of sensors: -- : 1 sensor
 4P : up to 4 sensors
 Fieldbus: PR : Profibus
 xx : all common fieldbusses
 Enclosure with plug connection

Example: E20-4P-PR-S for up to 4 sensors, data backup / remote control via fieldbus, these systems have always signal outputs with optocoupler and are completely equipment with connectors

Dimensions:

System E20:

Width: 140 mm (5.5 in)
 Height: 140 mm (5.5 in)
 Depth: 71 mm (2.8 in)

System E20-4P:

Width: 180 mm (7.1 in)
 Height: 140 mm (5.5 in)
 Depth: 71 mm (2.8 in)

System E20-(4P)-PR-S

Width: 225 mm (8.9 in)
 Height: 240 mm (9.5 in)
 Depth: 71 mm (2.8 in)

Sensors:

It is recommended to use the sensors P30GS, P42AGS and P75VGS with the control unit E20. The connection of the older P36GS, P42GS and P75GS sensors is also possible.

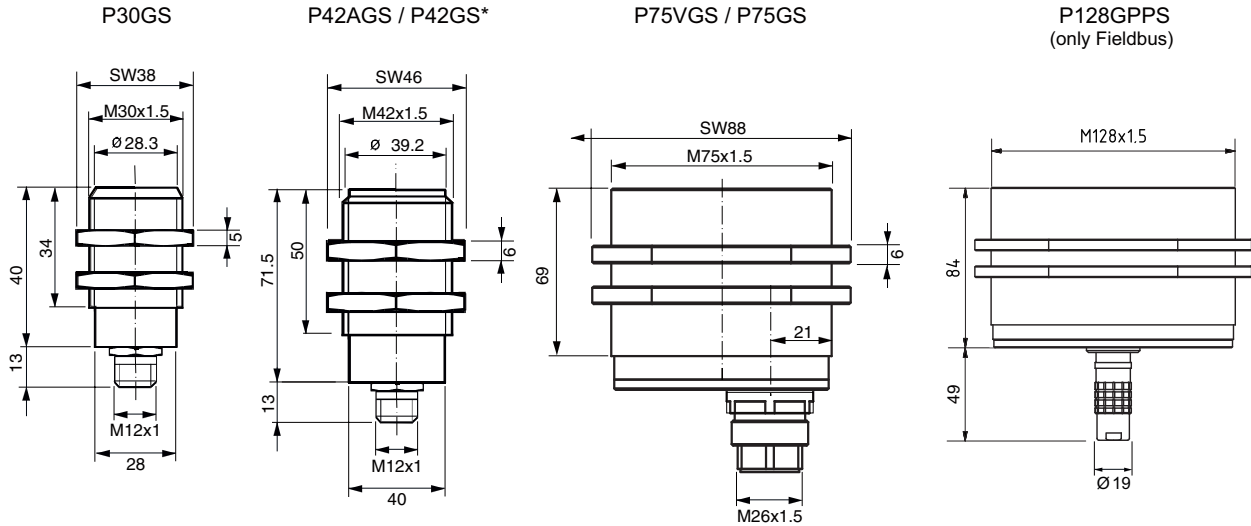

Air gap behavior:

The new Double Sheet Detector E20 has a much improved air gap tolerance especially in conjunction with the new sensor P42AGS. There are two types of air gaps in case of double sheet control.

First there is the air gap between sensor and sheet surface (1st air gap) and the air gap between the first sheet and the second sheet (2nd air gap). The diagrams show the relationship.

Example for 1st air gap with sensor P42AGS: According to the diagram, if processing a sheet of 2.0 mm (.08 in.) an air gap of 0.5 mm (.02 in.) can be tolerated with a double sheet threshold of 120 %.

Example for 2nd air gap and sensor P42AGS with 2.0 mm (.08 in.) sheet thickness and a double sheet threshold of 120 %; an air gap of up to 3.0 mm (.12 in.) can be tolerated.

Attention ! The performance data of both diagrams **cannot** be combined !

Max. air gap between sensor and first sheet (1st air gap)

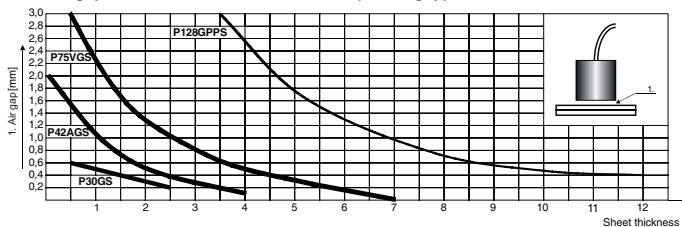

Max. air gap between first and second sheet (2nd air gap)

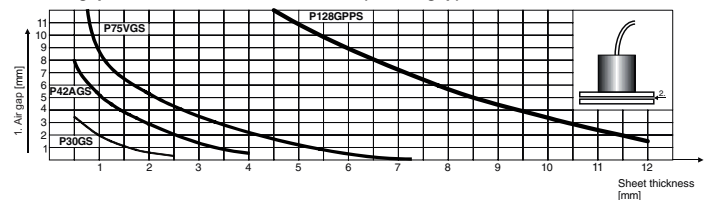

Measurement time:

The table to the right shows the reaction time of the system when detecting Double Sheet with the maximum sheet thickness applicable to each sensor and a selected upper switching limit of 120%.

The times for 2, 3 and 4 sensors apply to the **sequencer mode**.

Sensor	Max. Sheet thickness [mm]	Measurement time [ms] with max. sheet thickness and 120 % Double Sheet threshold			
		1 Sensor	2 Sensor	3 Sensor	4 Sensor
P30GS	2.5	55	105	160	215
P42AGS	4	80	180	280	375
P75VGS	6,5 (8*)	450	800	1220	1620
P128GPPS	11 (12*)	1150	1600	2050	2500

*with restriction

Order Data

Control units:

for the connection of one sensor:		for the connection of up to 4 sensors:		Description	
Part name					
E20-B-R	E20-4P-B-R			Control via PLC	Relay version
E20-B-O	E20-4P-B-O			Control via PLC	Opto coupler version
E20-C-O	E20-4P-C-O			Data backup, Control via PLC	Opto coupler version
E20-PR-S*	E20-4P-PR-S*			Data backup, Control via Profibus	

**all common fieldbus technologies are available*

Sensors:

Part name	Description
P30GS	Electro magnet up to 2.5 mm single sheet thickness (The sensor P30GS should only be used in case of confined space situations. The standard sensor should be P42AGS)
P42GS	Electro magnet up to 4,0 mm single sheet thickness
P42AGS	Electro magnet up to 4,0 mm single sheet thickness
P75VGS	Electro magnet up to 6,5 mm single sheet thickness
P128GPPS	Electro magnet up to 12,0 mm single sheet thickness

Sensor cables:

For P30GS + P42AGS:		For P128GPPS:		For all other sensors:	
Part name		Part name		Part name	Description
CPM12S-G				CPS-5-GOIL	Straight receptacle
CPM12S-W				CPS-5-WOIL	Right angle receptacle
SM12CPM12S-GG	SM12CPPPS-GG			SM12CPS-GG	Fieldbus technology, straight receptacle
SM12CPM12S-GW	SM12CPPPS-GW			SM12CPS-GW	Fieldbus technology, right angle receptacle

Standard cable length is 5 meters. Customized lengths up to 50 meters can be ordered; larger lengths upon request.

Sensor cable

Cable: CPS-5-GOIL for P42GS and P75VGS
Straight receptable

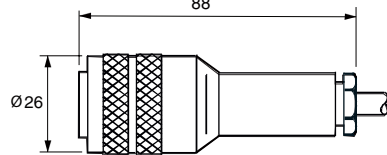

Cable: CPM12S-G for P30GS and P42AGS
Straight receptable

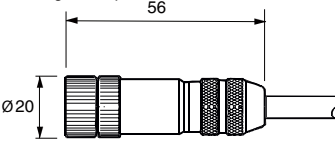

Cable: CPS-5-WOIL
Right angle receptable

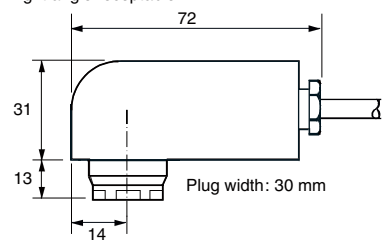

Cable: CPM12S-W
Right angle receptable

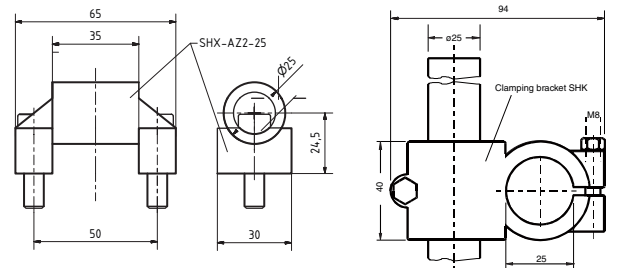
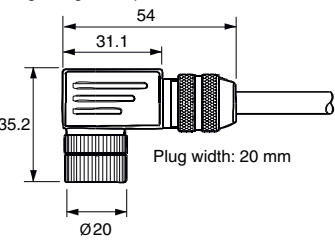

Sensor bracket:

Spring loaded sensor bracket with vacuum cup SHX42 for sensor P42(A)GS (also available: spring loaded bracket SHS; without vacuum cup available as type SH...GS)

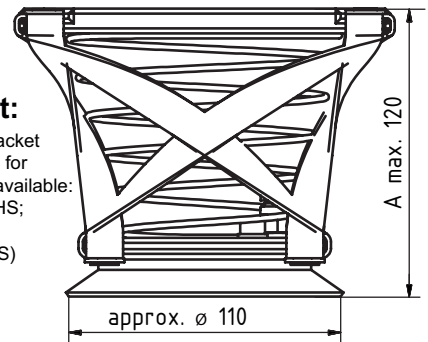

Special accessories:

Part name	Description	Part name	Description
SH42GS*	Spring loaded sensor brackets with vacuum cup (excepting SH42GS) for P42GS and P42AGS *no vacuum cup	SHK	Clamping bracket for SH42GS, SHS42GS (-85), SHS42G-FB (80)
SHS42GS / SHS42GS-85		SHX-AZ2-25	Adaptor (Shank) 25 mm for SHX42 / SHX42-DL
SHS42G-FB / SHS42G-FB80		2395110	Rubber lips for vacuum cup
SHX42 / SHX42-DL		RPP1000	Software for parameter back up on a PC (Version C only)

ROLAND ELECTRONIC GMBH

Otto-Maurer-Strasse 17
Phone: +49(0)7236-9392-0
info@roland-electronic.com

75210 Keltern / Germany
Fax: +49(0)7236-9392-33
www.roland-electronic.com

